

6. Detaljmontering

6.24 HÖRNSKÅPSINREDE CHILI

Hörnskåpsinrede utdrag Chili, art.nr. 30188 för skåp i bredd 1000 mm.
Vändbar höger/vänster skärmskåp.

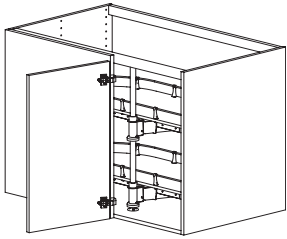

INNEHÅLL

6x
Art.nr. 270764



8x
Art.nr. 270715



2x
M4x6



4x
Art.nr. 270734



1x
Art.nr. 270719



MONTERING

- Mät 350 mm från insidan på höger eller vänstra skåpsida beroende på vilken modell du har. Mät 49 mm från framkanten på botten för placering av centrumskraven i det nedre stolp-fästet. Använd den medskickade mallen "Left Cupboard 40".

Vänstermodell

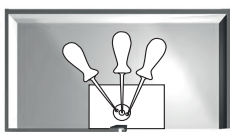

3x
270764



Högermodell

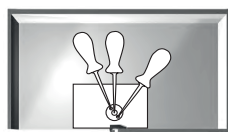

3x
270764

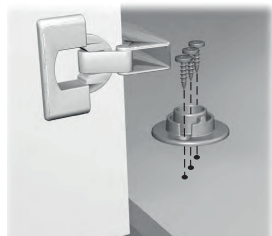

Vänster-och högermodell

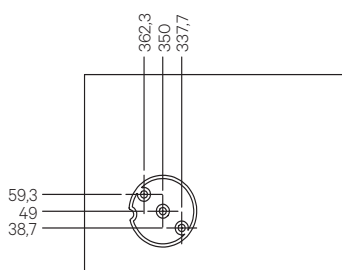

2

Vänstermodell

Högermodell

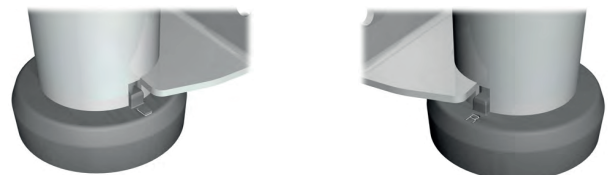
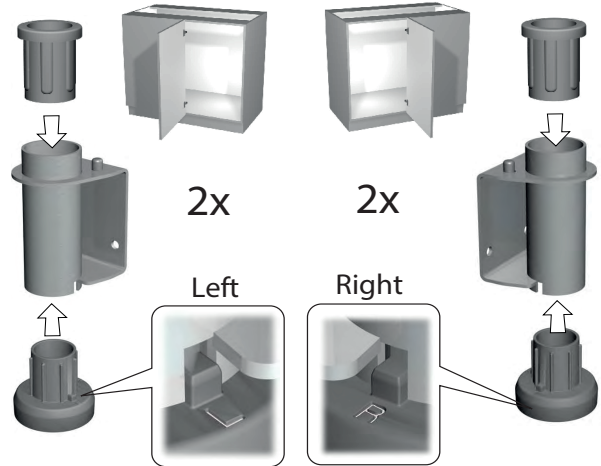

3

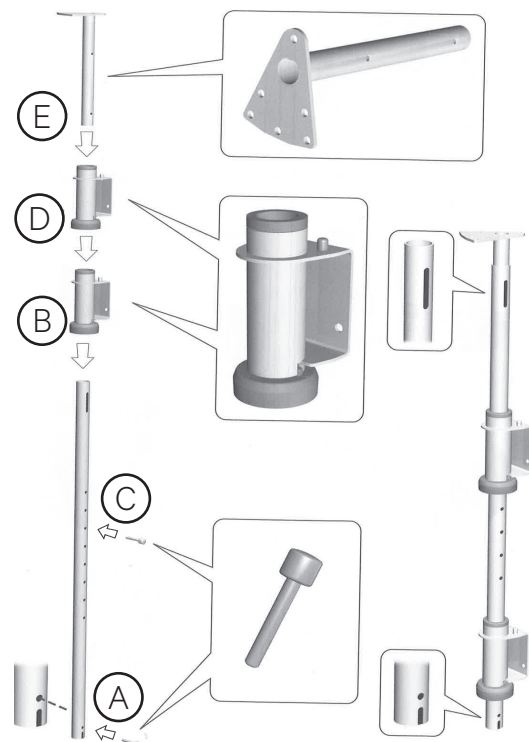

6. Detaljmontering

6.24 FORTS. HÖRNSKÅPSINREDE CHILI

